

# AceCom Networks

**VCL-MX™ Version 2-STD (Standard Version)  
E1, 2 Mbps 30 Channel Drop-Insert  
Voice and Data Multiplexer**

---

**VCL-MX, Voice and Data Multiplexer**

---

Product Brochure & Data Sheet

**AceCom Networks Pte Ltd.**  
200 Jalan Sultan, #02-13 Textile Centre,  
Singapore 199018  
**Phone:** +65 6295 3233, **Fax:** +65 6295 3133  
**E-mail:** sales@acecomnet.com  
**Web Site:** <http://www.acecomnet.com>

## Product Overview

The VCL-MX Version 2-STD (Standard Version), 2Mbps ~ 30 Channel E1 Voice and Data, Drop-Insert Multiplexer provides full range of POTS (voice) and digital data services to subscribers located at different locations, requiring to interconnect and establish a voice and data network over an E1 link. The VCL-MX Version 2-STD is a simple, yet powerful E1 Channel Bank for connecting and integrating analog communication equipment with digital E1 interface.

The VCL-MX Version 2-STD, E1, Drop-Insert Multiplexer provides voice telephony and digital data services which may include:

### The Multiplexer may be used in Terminal or Drop-Insert configuration to provide:

- Toll Quality Voice Services
- Interconnect LAN (Campus Network)
- Interconnect Computer Terminals
- Provide LAN-WAN Interconnectivity
- Provide Leased Lines on DSL for SOHO Applications

### Voice Interfaces

- FXO
- FXS
- E&M (2 Wire and 4 Wire)
- FXS-FXS (Hot-line)
- E&M - Ext (User configurable gain/attenuation)

### Data Interfaces

- RS232
- G.703 @ 64 Kbps, co-directional
- iDSL@128 Kbps

## Features

- Voice and Digital Data services
- Any combination ("mix-n-match") of Voice and Digital Data services deployed from a single VCL-MX "Smart Shelf"
- Drop and Insert applications
- Digital Data option may be used for internet access or video conferencing application
- Wireless applications including Cellular Networks
- Digital Microwave Radio
- Frame Relay circuit termination
- Powerful Network Management System for monitoring and network control
- Compliance with all relevant ITU-T (CCITT) recommendations
- 3 U High, compact construction



### VCL-MX Version 2-STD, E1, Drop-Insert Voice and Data Multiplexer

The VCL-MX Version 2-STD, E1 Interface operates at a primary rate of 2.048 Mbits/sec and provides a host of features including, channel drop and insert facility over a network of MX E1 Multiplexers, for voice and data applications.

The VCL-MX Version 2-STD, has an effective, CLI (text) and GUI (Graphical User Interface) based "Network Management System", which may be used for configuring the system, subsequent remote monitoring and management of the inter-connected systems in the network. Both Inband and Out-of-Band configuration and monitoring options are available. Remote monitoring and management of the inter-connected systems.

An extensive set of alarms, for easy maintenance are provided in the system.

## Highlights

- Field upgradable to provide voice, data or both services
- Flexibility on use of transmission medium-copper, fiber or wireless
- Choice of Interfaces for Data Applications
- RS-232, PC Interface "Network Control and Management Software"
- In-band system configuration and management interface
- Out-of-band system configuration and management interface through 10BaseT Terminal (Optional)
- Channel assignment independent of slot position in the sub-rack
- Extensive set of alarms
- User Selectable Internal or Loop-timed clock options

## Transmission Mediums

The MX offers an excellent flexibility on the choice of transmission medium over which it may be deployed. The transmission medium can be either of the following:

- Copper
- Optical Fiber
- Wireless

## Applications of VCL-MX Version 2-STD

- POTS (voice) and low speed (64 Kbps) data
- Junction Mux - for digital interconnection of analog exchanges
- Drop & Insert applications
- Wireless network applications
- Micro-Cellular infrastructure applications for providing cell-switch connectivity
- Wide area networking

### VCL-MX Version 2-STD (Standard Version) - Front View

Voice and Data Drop-Insert Multiplexer with In-band Management Interface

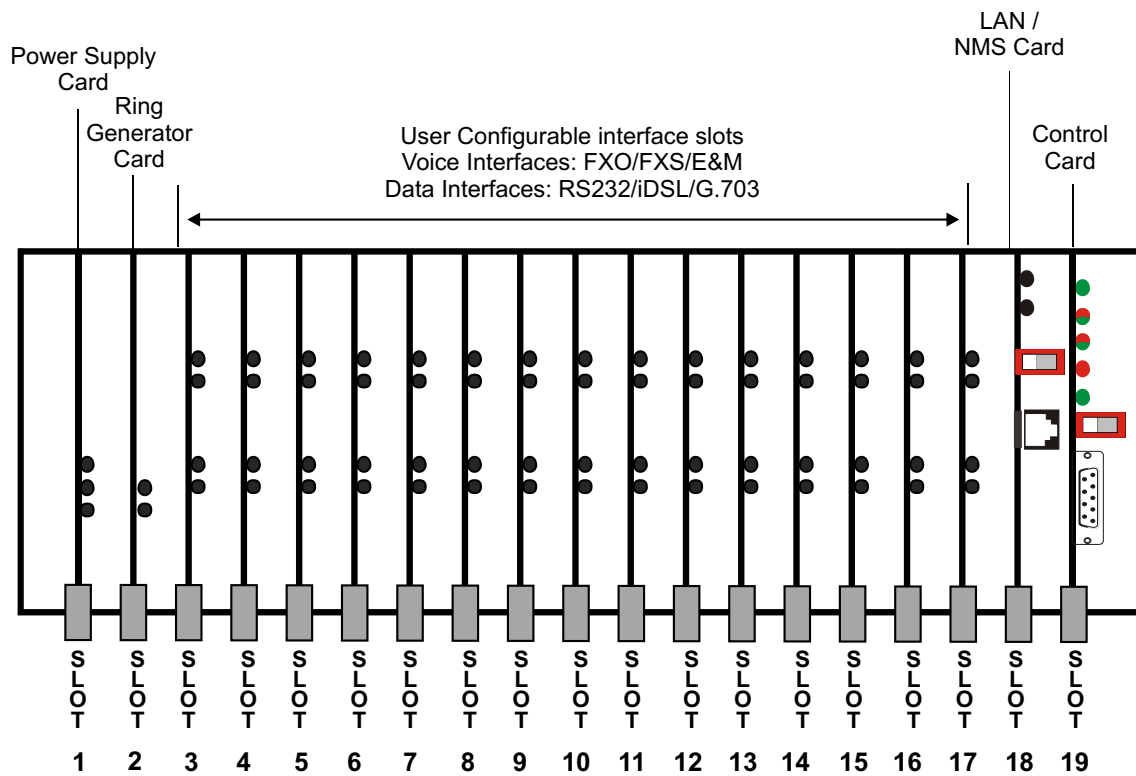

### VCL-MX Version 2-STD (Standard Version) - Back View

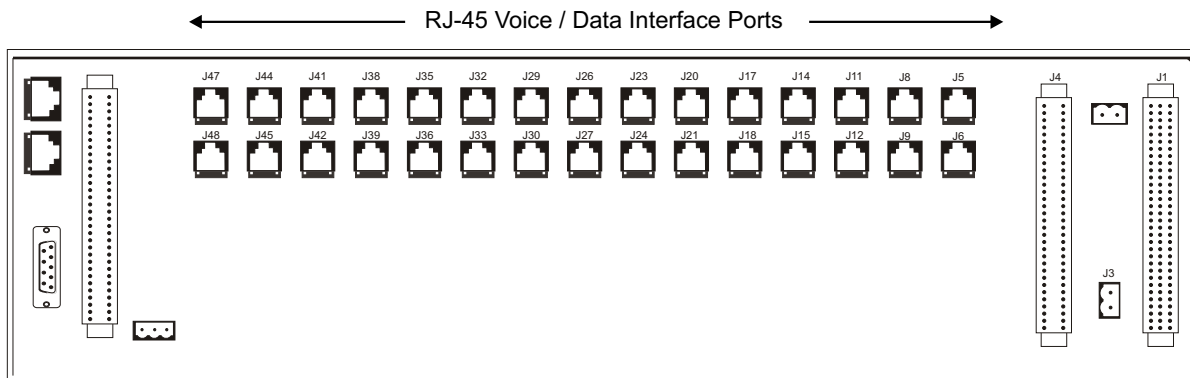

### System Composition

Core System Composition	Description	Part No.
19-Inch Shelf 3U high	19- Inch Shelf and Backpanel	VCL-MX-002/120
Slot 1	Power Supply Card	VCL-MX-010
Slot 2	Ringer Card	VCL-MX-040
Slot 3 to Slot 17	15 User Configurable voice & data interface(s)	As per user requirement
Slot 18	LAN / NMS Card	VCL-MX-NMS
Slot 19	Control Card with In-Band Management Interface	VCL-MX-015-2

## Applications

### Applications # 01

#### VCL-MX E1, 2Mbps Voice & Data Multiplexers Connecting over Digital Microwave Radio Links

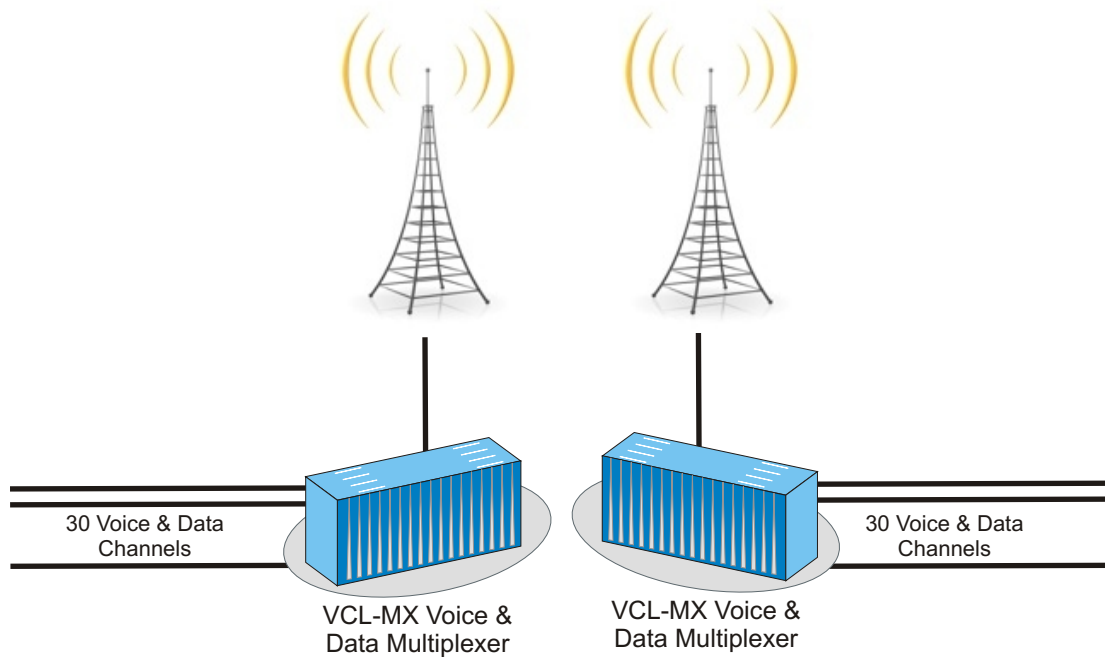

### Applications # 02

#### VCL-MX E1, 2Mbps Voice & Data Multiplexer Connecting over Digital Satellite Circuits

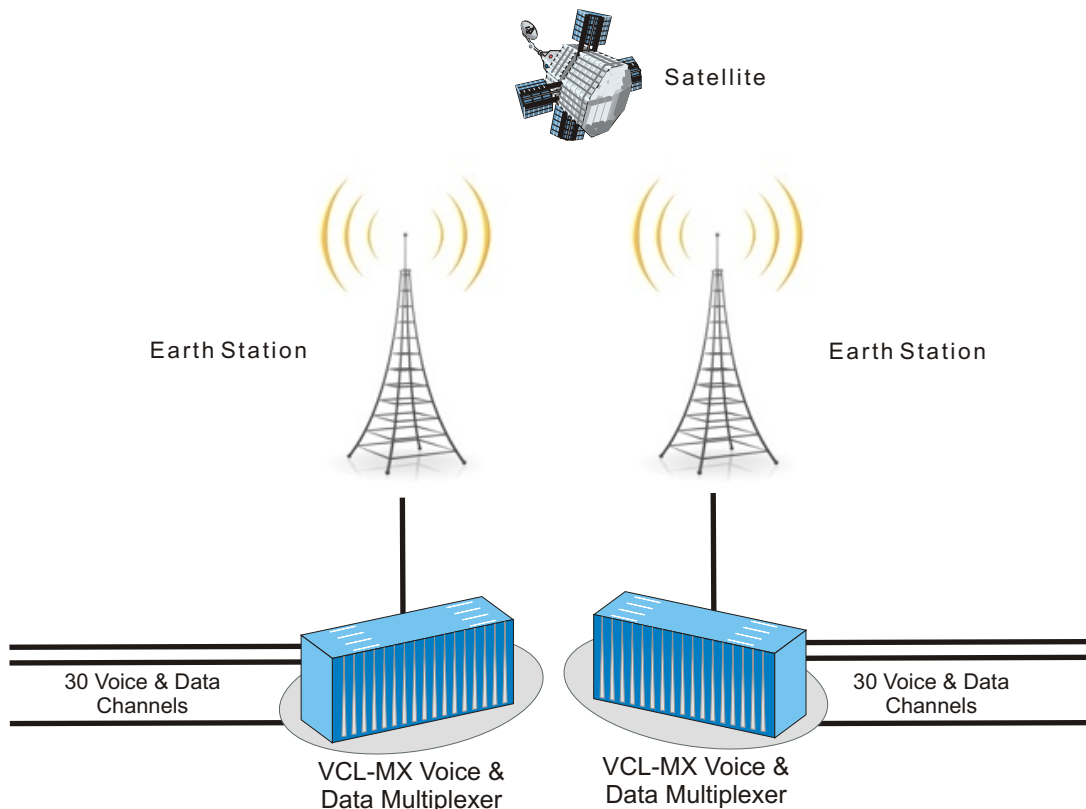

**Applications # 03**

**VCL-MX E1, 2Mbps Voice & Data Multiplexers  
Connecting over Optical Fiber Links**

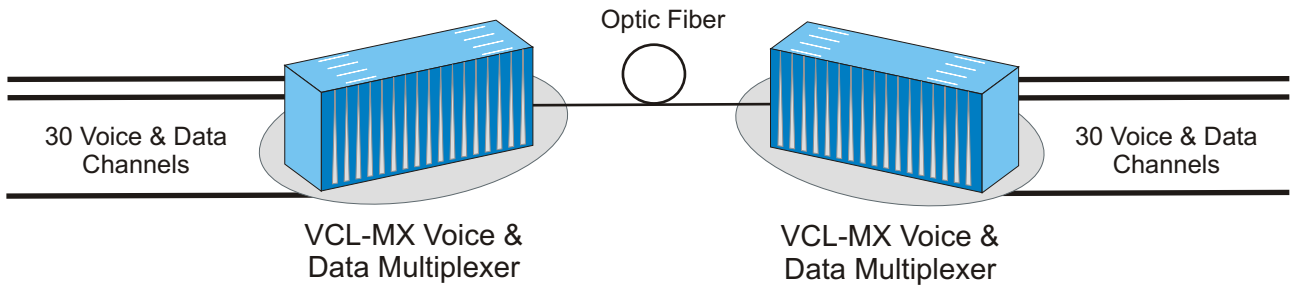

**Applications # 04**

**VCL-MX E1, 2Mbps Voice & Data Multiplexer  
Connecting over HDSL Links**

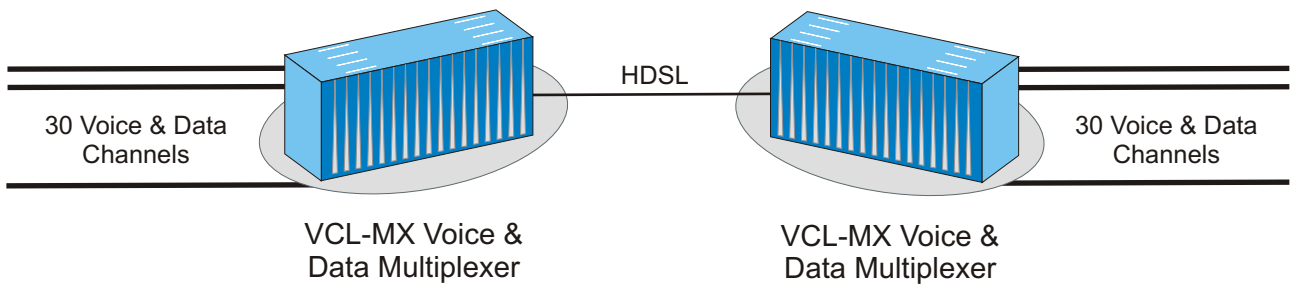



**Applications # 05**

**VCL-MX E1, 2Mbps Voice & Data Multiplexer**

**Connecting at the Central Office/Switch - E & M Interfaces**

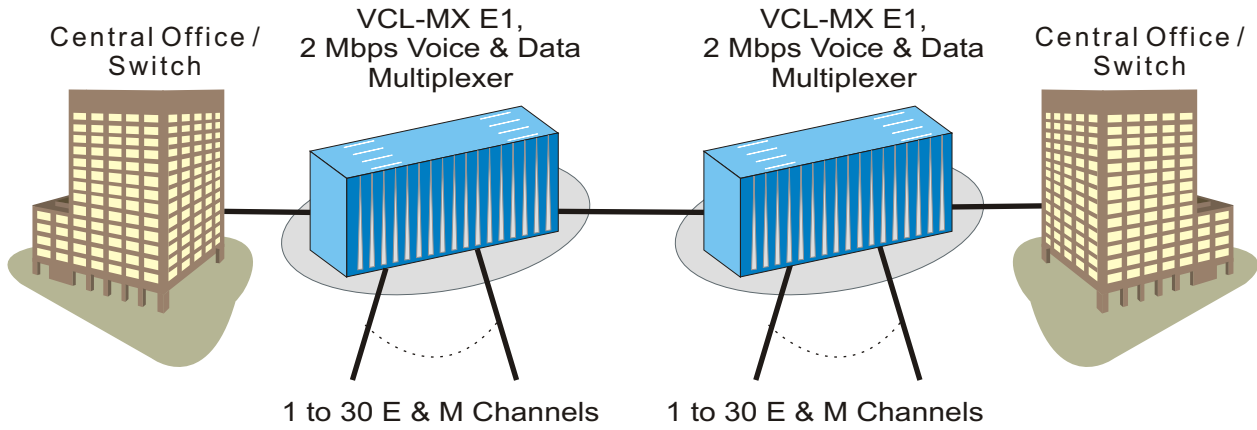

**Applications # 06**

**VCL-MX E1, 2Mbps Voice & Data Multiplexer**

**Using in a Subscriber Loop Point to Point or Drop/Insert Application**

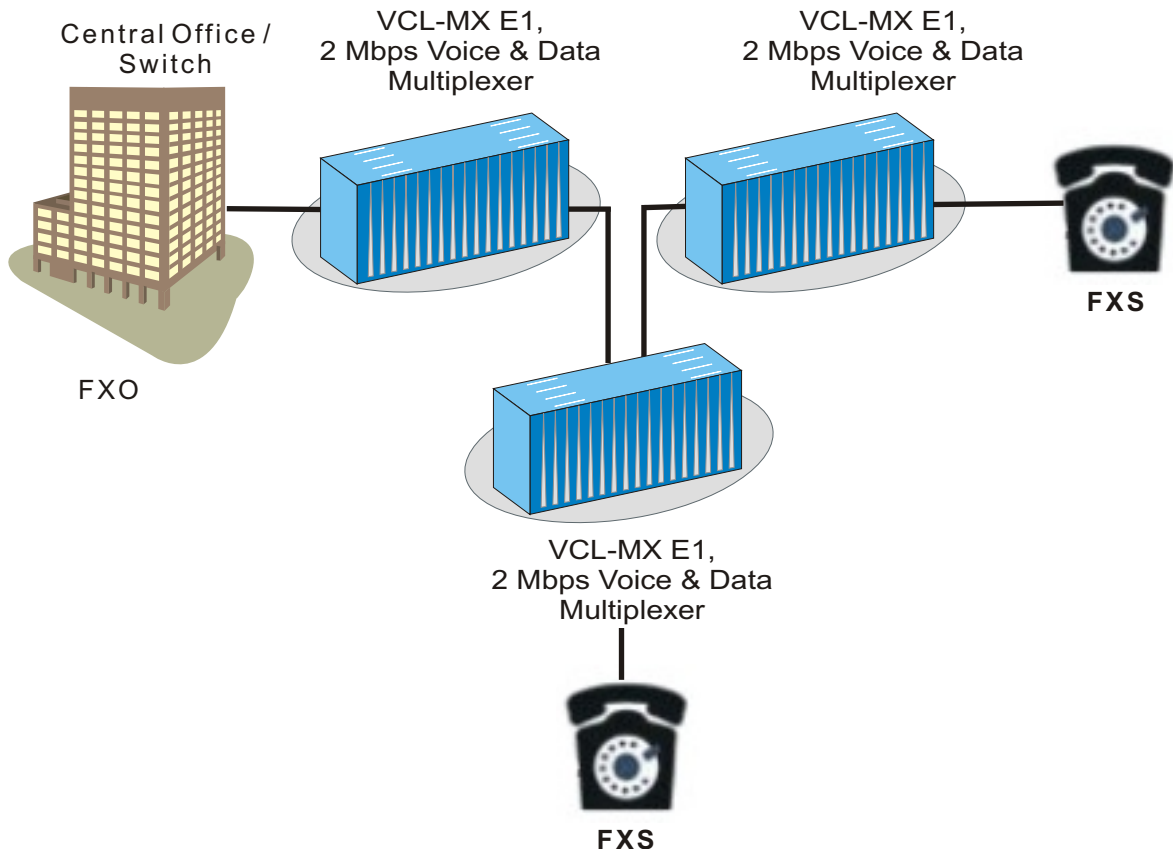

**FXO/JNC 2 wire exchange loop interface card**  
**FXO/SLC 2 wire subscriber loop interface card**

## User Configurable Interface Card

<p><b>Voice Interface</b></p> <ul style="list-style-type: none"> <li>• POTS service from a Central Office Switch (FXO &amp; FXS)</li> <li>• Hot Line (FXS-FXS)</li> <li>• 2 Wire and 4 Wire, E&amp;M applications</li> <li>• 15W, sine-wave, 75VRMS / 86VRMS 20Hz/ 25 Hz Ringer for FXS and Hot-line (FXS-FXS) interfaces</li> </ul>	<p><b>System Management</b></p> <ul style="list-style-type: none"> <li>• Serial RS232 - COM Port</li> <li>• 10/100BaseT Ethernet Port for remote management over a LAN / TCP-IP network</li> </ul> <p><b>Data Interfaces</b></p> <ul style="list-style-type: none"> <li>• RS232</li> <li>• G.703 @ 64 Kbps, co-directional</li> <li>• iDSL @ 128 Kbps</li> </ul>
--	--

## Technical Specifications - E1 Interface (Main Link)

Number of Interfaces	2
Conformity (Electrical)	G.703
Frame Structure	As per ITU (CCITT) G.704
Signaling	Channel Associated Signaling
PCM Sampling Rate	8000 Samples/sec
Encoding Law	A Law as per ITU (CCITT)
Bit Rate	2048 Kbps ± 50 ppm
Code	HDB3
Nominal Impedance	120 Ω balanced / 75 Ω unbalanced (75 Ω option)
Peak Voltage of a mark For 120 Ω Balanced interface 75 Ω Unbalanced interface	3.0 V ± 0.3 V 2.37 V ± 0.237 V
Peak Voltage of a space for 120 Ω Balanced interface 75 Ω Unbalanced interface	0 V ± 0.3 V 0V ± 0.237 V
Nominal Pulse Width	244 ns
Pulse Mask	As per ITU (CCITT) Rec. G.703
Output Jitter	< 0.05 UI (in the frequency range of 20Hz to 100 KHz)
Permissible Attenuation	6 dB at 1 MHz
Return Loss at: 51.2 KHz to 102.4 KHz 102.4 KHz to 2048 KHz 2048 KHz to 3072 KHz	> 12dB > 18dB > 14dB
Jitter Tolerance	As per ITU (CCITT) G.823
Loss and recovery of frame alignment	As per clause 3 of ITU (CCITT) G.732
Loss and recovery of multiframe alignment	As per clause 5.2 of ITU (CCITT) G.732



## 2 Wire - Voice Frequency Interface(s) - FXS (VCL-CB-025)

Number of Channels per Card	2
Interface Type	FXS
Maximum Number of Channels	30
Transmission performance	Fully Compliant to ITU (CCITT) G.712 (G.713, G.714) specification
Line Impedance	600Ω (900Ω optional)
Voice Channel Frequency	300Hz-3400Hz
Insertion Loss	-2.0dB Nominal (User adjustable)
Idle Channel Noise	≤-65dB
Return Loss	300Hz - 600Hz - ≥ 12dB 600Hz - 3400Hz - ≥ 15dB
Longitudinal Balance	≥ 46dB between 300Hz to 3400Hz
Ring Frequency	25 Hz (20Hz, Optional)
Ring Voltage	≥ 75 volts RMS into a load of 5 R.E.N. With a 0.30 Erlang traffic pattern
Subscriber Loop Current	≥ 23mA into a subscriber loop of 1000 Ohms
Overload Level	+3.14dBm ± 0.5dBm
Battery Reversal	All channels
Dial Pulse Speed	8-12 pps - Pulse Dialing / DTMF Dialing

## 2 Wire - Voice Frequency Interface(s) - FXS (VCL-CB-025-EXT)

Number of Channels per Card	2
Interface Type	FXS - Ext
Maximum Number of Channels	30
Transmission performance	Fully Compliant to ITU (CCITT) G.712 (G.713, G.714) specification
Line Impedance	600Ω (900Ω optional)
Voice Channel Frequency	300Hz-3400Hz
Insertion Loss (nominal)	-2dB (user adjustable range of -2dB to -8dB)
User selectable range for insertion loss	1dB to 7dB
Input level minimum	-11dB
Input level maximum	3.2dB
Transmit Gain	0 to 16dB (user configurable)
Receive Attenuation	0 to 16dB (user configurable)
Idle Channel Noise	≤ -65dB
Return Loss	300Hz - 600Hz - ≥ 12dB 600Hz - 3400Hz - ≥ 15dB
Longitudinal Balance	≥ 46dB between 300Hz to 3400Hz
Ring Frequency	25 Hz (20Hz, Optional)
Ring Voltage	≥ 75 volts RMS into a load of 5 R.E.N. with a 0.30 Erlang traffic pattern
Subscriber Loop Current	≥ 23mA into a subscriber loop of 1000 ohms
Overload Level	+3.14dBm ± 0.5dBm
Battery Reversal	All channels
Dial Pulse Speed	8 -12 pps - Pulse Dialing/DTMF Dialing

**2 Wire - Voice Frequency Interface(s) - FXO (VCL-CB-030)**

Number of Channels per Card	2
Interface Type	FXO
Maximum Number of Channels	30
Transmission performance	Fully Compliant to ITU (CCITT) G.712 ( G.713, G.714) specification
Line Impedance	600 Ω (900 Ω optional)
Voice Channel Frequency	300Hz-3400Hz
Insertion Loss	-2.0dB Nominal (User adjustable)
Idle Channel Noise	≤ -65dB
Return Loss - 2 wire	300Hz - 600Hz - ≥ 12dB 600Hz - 3400Hz - ≥ 15dB
Longitudinal Balance	≥ 46dB between 300Hz to 3400Hz
Ring Frequency	25 Hz (20Hz, Optional)
Ring Voltage	≥ 75 volts RMS into a load of 5 R.E.N. with a 0.30 Erlang traffic pattern
Subscriber Loop Current	≥ 23mA into a subscriber loop of 1000 ohms
Overload Level	+3.14dBm ± 0.5dBm
Battery Reversal	All channels
Dial Pulse Speed	8 -12 pps - Pulse Dialing/DTMF Dialing

**E&M 2 Wire / 4 Wire Voice Frequency Interface (VCL-CB-035)**

Number of Channels per Card	2
Interface Type	2W / 4W E&M
Maximum Number of Channels	30
Transmission performance	Fully compliant to ITU (CCITT) G.712 Specification
Line Impedance	600 Ohms
Voice Channel Frequency	300Hz-3400Hz
Insertion Loss / Gain	-2.0dB Nominal (User adjustable between 0dB and 16dB)
Idle Channel Noise	≤-65dB
Return Loss	300Hz - 600Hz - ≥ 12dB 600Hz - 3400Hz - ≥ 15dB
Longitudinal Balance	≥ 46dB between 300Hz to 3400Hz
Overload Level	+3.14dBm ± 0.5dBm
E&M Signaling Rate	10 pps

## 2 Wire / 4 Wire - Voice Frequency Interface(s) - E&M (VCL-MX-035-EXT)

Number of Channels per Card	2
Interface Type	E&M - Ext
Maximum Number of Channels	30
Transmission performance	Fully Compliant to ITU (CCITT) G.712 (G.713, G.714) specification
Line Impedance	600Ω (900Ω optional)
Voice Channel Frequency	300Hz-3400Hz
Insertion Loss (nominal)	-2dB (user adjustable range of -2dB to -8dB)
User selectable range for insertion loss	1dB to 7dB
Input level minimum	-11dB
Input level maximum	3.2dB
Transmit Gain	0 to 16dB (user configurable)
Receive Attenuation	0 to 16dB (user configurable)
Idle Channel Noise	≤ -65dB
Return Loss - 2 wire	300Hz - 600Hz -> 12dB 600Hz - 3400Hz -> 15dB
Return Loss - 4 wire	300Hz - 3400Hz -> 20dB
Longitudinal Balance	≥ 46dB between 300Hz to 3400Hz
Overload Level	+3.14dBm ± 0.5dBm
Dial Pulse Speed	Pulse / MFC Dialing / DTMF Dialing

## Low Speed Data Interface RS232

Interface	RS232
Number of Interfaces per Card	2
Maximum Number	30
Conformity	RS232
Mode	Asynchronous
Bit Rate	50 Kbps to 19.2 Kbps
User Interface	DCE
Character Length	5 / 6 / 7 / 8 (Auto-Select)
Stop Bits	1 / 1.5 / 2 (Auto-Select)
Parity	Even / Odd / 0's / 1's / none (Auto-Select)

## G.703 @ 64kbps, Synchronous Data Interface

Interface	G.703 @ 64 Kbps
Number of Interfaces per Card	2
Maximum Number	30 64Kbits / sec. Interface
Conformity	To (CCITT) Rec. G.703
Mode	Synchronous, Co-directional
Bit Rate	64Kbps

## iDSL - ISDN DSL

"U" Interface	Meets ANSI T1.601-1992 requirements
Line Rate	160 Kbits/s
Frame Format	2B as per CCITT Rec.1.430
Line Code	2B1Q as per CCITT Rec.G.961
Accepted Line Attenuation	42dB at 40 KHz
Pulse Shape	As per CCITT Rec.G.961
Multiplexer Emulation	LT Emulation
Customer Premises Equipment	NT Emulation
Impedance	135 Ohms at 40KHz

Maximum distance: 5 km (4 miles) on 0.5 mm twisted Pan. Distance may vary with cable guage. For distance using various cable guages please refer chart below.

Distance in kms. (Miles)				
Data Rate (Kbps)	Wire Gauge (AWG/mm)			
	19 (.9mm)	22 (.6mm)	24 (.5mm)	26 (.4mm)
128 / 144	17.4 (10.8)	11.6 (7.2)	8.1 (5.0)	5.5 (3.4)

## Protection

Central Office Terminal and Remote Terminal are protected against power surges and transients occurring from lightning and electric induction as per CCITT Rec. Table I/K-20 towards line side.

## Clock

Timing Options	Internal Clock, Loop-Timed Clock
Synchronization Sources	Internal Clock, span clock timing derived from incoming HDB3 links (Loop-Timed)
Default Option	Internal Clock

## Management Interface

### Local Management Interface

RS232, operating @ 9.6 Kbps CLI (text) based Interface, Hyper Terminal (VT-100 Emulation)
---

### In-band Management Interface for Remote Terminals

RS232, operating @ 9.6 Kbps CLI (text) based Interface, Hyper Terminal (VT-100 Emulation)
---

### Out-of-Band Management Interface - Optional

10/100BaseT - User Assigned IP Address
Graphical User Interface (GUI)

## Environmental

Temperature and Humidity	0°C to + 50°C, 90% R.H. (Non-condensing)
Altitude	upto 9,000 feet

## Power Supply

Input DC Voltage	-48V DC ( nominal )
Range of Input	-40V to -60V DC
Output Voltages	+5V, -5V, filtered -48V (for term. cards)
Full Load Output Current	8A at +5V, 0.5A at -5V
Input Voltage Reversal Protection	Provided in the Card
Over Current Protection	10A for +5V, 1.0A for -5V
Short Circuit Protection	Current limit - 6A. Recovers on removal of short
Efficiency at Full Load	>86%
Ripple at Full Load	<5mVrms
Spike at Full Load	<50mV
Power Consumption	21W - with all 30 Voice Circuits

## Mechanical Specification

Rack Mounting	Standard 19 inch DIN rack
Height	3U (133.33 mm)
Depth	292 mm
Width	483 mm
Weight	7.00 Kgs.



### Ordering Information

<b>VCL-MX E1 Core System (Common Equipment)</b>			
<b>S. No.</b>	<b>Part #</b>	<b>Product Description</b>	<b>Qty</b>
1	VCL-MX-015-2 (CLI)	Control Card, 30 Channel E1 Interface	1
2	VCL-MX-001	19" Shelf 3U High (Sub-rack) to accommodate 30 Voice & Data Channels fitted with Connectorized backplane	1
3	VCL-OAM-1440-5.0	OAM - Operations and Management Card for connecting the multiplexer to be managed in a LAN - allows the USER to assign a unique IP address to each multiplexer connected in a LAN to be managed from a single point. Telnet, SNMP V2, GUI, In-band and Out-of-band management.	1
4	VCL-MX-010	(-) 48V DC Input Power Supply Card, Dual Supply 30 Channel Power Supply Card (+5V DC, -5V DC)	1

<b>VCL-MX, User Configurable Interface</b>			
<b>S. No.</b>	<b>Part #</b>	<b>Product Description</b>	<b>Qty</b>
1	VCL-CB-025	Dual Port VF, RT (FXS) Line Interface Card 2, 64Kbps/Sec. VF Channels per Remote Terminal Line Card 15 (max) per system	1
2	VCL-CB-025-EXT	Dual Port VF, RT (FXS) Line Interface Card 2, 64Kbps/Sec. VF Channels per Remote Terminal Line Card 15 (max) per system (programmable Tx and Rx level settings)	
3	VCL-CB-027	Dual Port VF, Hot-Line (FXS - Ring-Down) Line Interface Card 2, 64Kbps/Sec. Hot-Line Channels per Card 15 (max) per system	1
4	VCL-CB-030	Dual Port VF, CO (FXO) Line Interface Card 2, 64Kbps/Sec. VF Channels per Central Office Line Card 15 (max) per system	1
5	VCL-CB-035	Dual Port, E & M Cards, 2 Wire/4 Wire E&M Trunk Interface Card 15 (max) per system	1
6	VCL-CB-035-EXT	Dual Port E&M Card, 2 Wire / 4 Wire E & M Trunk Interface Card 15 (max) per system (Programmable Tx and Rx settings / VF range 0 to -15dB (gain)	1
7	VCL-CB-040	Ring Generator Card, Central Office Ring Generator Card 1 per system	1
8	VCL-CB-045	Dual Port, RS232 Data Interface Card, Up to 19.2Kbps RS232 Asynchronous Data Interface Card, 2 Interfaces per Card 15 (max) per system	1
9	VCL-CB-060	Dual Port, G.703, Co-Directional Data Interface Card 64Kbps Co-Directional G.703 Data Interface Card, 2 Interfaces per card 15 (max) per system	1
10	VCL-CB-080	iDSL Modem Card Central Office/ISP Multiplexer Side - transports 128 Kbps on a single twisted copper pair upto 5 KM (ISDN DSL)	1



### Ordering Information

Optional and Accessories			
S. No.	Part #	Product Description	Qty
1	VCL-30-01048	Power Supply (External) AC to DC Converter Portable External Converter Universal AC Input [93VAC-276VAC, 47Hz-63Hz] to DC Output [(-)48V DC] - Optional 1 (Supports 1 channel bank)	1
2	VCL-30-01048 19-RK	Power Supply (External) AC to DC Converter External Converter ] Universal AC Input [93V AC-276V AC, 47Hz-63Hz] to DC Output [(-) 48V DC] - Optional 2 (Supports up to 4 channel banks)	1
3	VCL-30-120/75-1 Converter	1 E1, 75 Ohms to 120 Ohms Converter, G.703 Transformer Module (Balun) with RJ-45 and Female BNC	1
4	VCL-30-120/75-16 Converter	16 E1, 120 Ohms to 75 Ohms (BNC) Converter Panel - 19 inch Rack Mount version, RJ-45 Connection on 120 Ohms/BNC (female) connection on 75 Ohms, with RJ-45 cables	1
5	BNC to BNC Cables	BNC to BNC Cable	1
6	Cables	RJ-11 connectorized Cables for FXS/FXO Cards RJ-11 to RJ-11(30 Cables per one multiplexer)	1
7	Cables	E&M Connectorized Cables (30 Cables per one multiplexer)	1
8	Cables	RS232 Connectorized Cables (30 Cables per one multiplexer)	1
9	Cables	G.703 Connectorized Cables (30 Cables per one multiplexer)	1
10	Cables	iDSL Connectorized Cables (15 Cables per one multiplexer)	1
11	Cables	E1 Interface - RJ-45 Connectorized Cable (Straight-through and Cross-Over Cable - 1, ea.)	1
12	Cables	NMS Connectorized Cables	1
13	Cables	LMS Cables	1
14	Manual	Documentation User Manual & System Software Disks	1

Notes : \_\_\_\_\_  
\_\_\_\_\_  
\_\_\_\_\_  
\_\_\_\_\_  
\_\_\_\_\_  
\_\_\_\_\_  
\_\_\_\_\_  
\_\_\_\_\_  
\_\_\_\_\_  
\_\_\_\_\_

Technical specifications are subject to changes without notice.  
All brand name and trademarks are the property of their respective owners.  
Revision 04 - March 16, 2011

**AceCom Networks Pte Ltd.**  
200 Jalan Sultan, #02-13 Textile Centre,  
Singapore 199018  
**Phone:** +65 6295 3233, **Fax:** +65 6295 3133  
**E-mail:** sales@acecomnet.com  
**Web Site:** http://www.acecomnet.com